

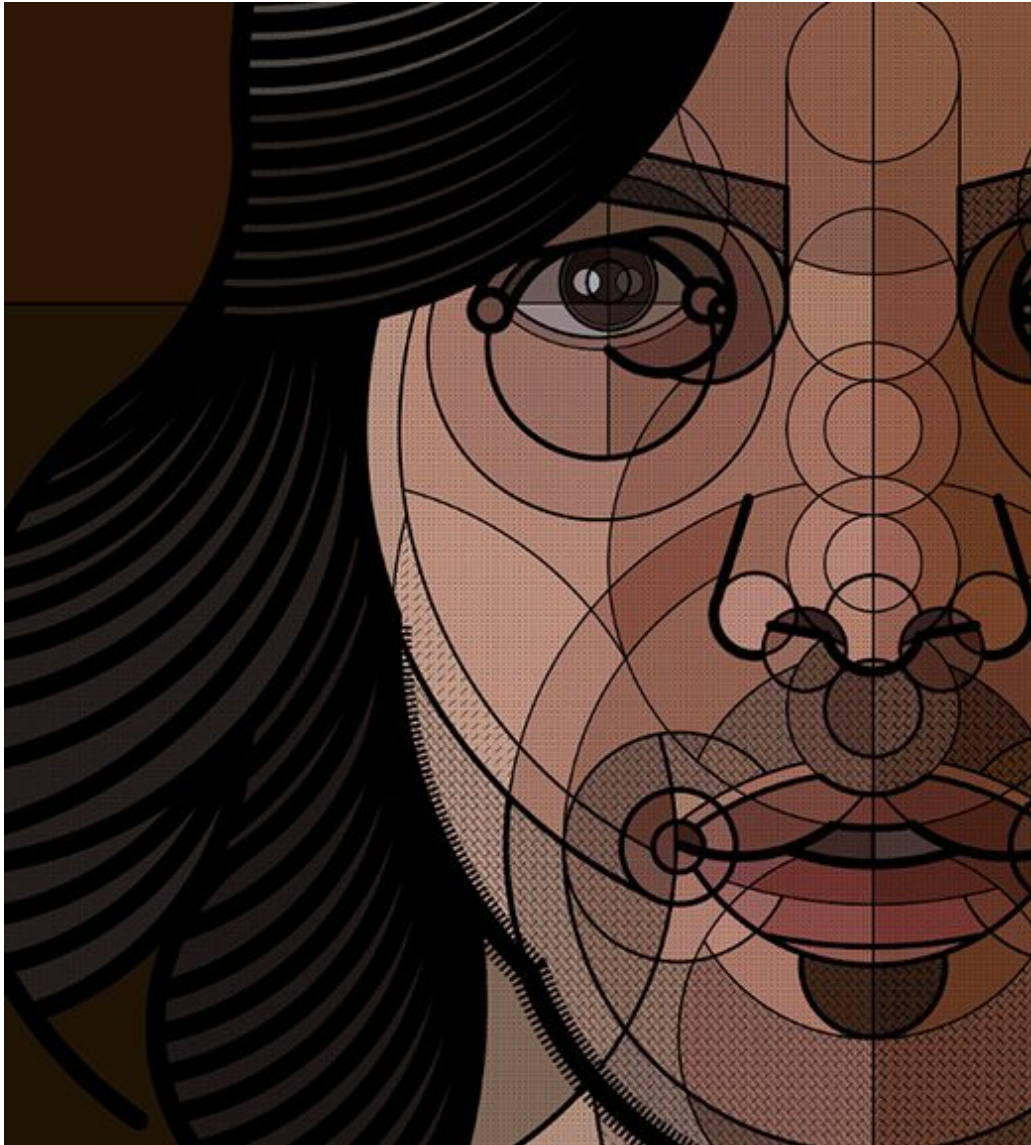

Browse 30.000 pages right here [All](#)





 39511 Follower 7293 Follower

Q+ 

279,95 CHF		

[LATEST](#) [POPULAR](#)
[RANDOM](#) [TAGS](#)



Zin Helena Song & Scott Anderson at CES

March 19, 2015

The CES Gallery, aka Carl E. Smith Gallery, continues to offer a great selection of exhibitions. After the six-artists group show titled When It Is Dark Enough and the first solo...

FIFTEEN SECONDS OF FAME AT SOON GALLERY

[Pin it](#)

March 18, 2015 • Steve Gray

There is no doubting the power social media has over our lives in contemporary society, its impact has been quite unnerving at times in recent years. Social media has become an integral part of our personal and work lives, shaping our visual culture and enabling the individual to shape and redefine how they present themselves to the outside world. Swiss artist Ata Bozaci, otherwise known as graffiti artist Toast, has been exploring the world of Facebook profiles for his latest project, *Beautiful Facebook – Fifteen Seconds of Fame*, which will be presented in a solo exhibition at SOON Gallery in Bern. *Beautiful Facebook – Fifteen Seconds of Fame* by Ata Bozaci will also serve as a book presentation, featuring a collection of digital portraits of the Facebook profiles of his friends. SOON Gallery, that has spaces in

both Bern and Zurich, has presented in the past, exhibitions by Buro Deconstruct and Uldry (*It's A Dedication*) and VinZ (*Fish Tank*).



Left: Ata Bozaci – Yagmur Ruezgar / **Right:** Ata Boza



Kate Steciw and Yannick Val Gesto

March 19, 2015

The Levy.Delval Gallery in Brussels is organizing an extraordinary exhibition entitled Soul Hackers. The show's title is directly referring to the works by two amazing...



Building a Collection: The First Steps

March 18, 2015

Anyone can start an art collection. The question is do you want your collection to be a professional one, or are you collecting pieces of art just for fun. The latter is usually a...



Art Degree for Yeezus?

March 18, 2015

Facebook Profiles & Fifteen Seconds of Fame

The solo exhibition at SOON Gallery, *Beautiful Facebook – Fifteen Seconds of Fame*, finds Ata Bozaci working in the tradition of artists reflecting personal events and the latest developments in society. The title of the exhibition of course refers to the classic Andy Warhol statement, that everyone would get their fifteen minutes of fame. Even Warhol could have not predicted that in such a small span of time the effect the internet and social media would have on the notion of fame and exhibitionism. Such is the impact of social media and to some extent, TV also, that we now live in a fast paced world of micro-moments that have shortened the attention span, those fifteen minutes are more like fifteen seconds now. By using the Facebook profiles of his friends, Ata Bozaci has explored the world of self-representation as a basis for his digital portraits and quite literally assembled his own face book. You may find the articles on Digital Urban Art and Urban Art's Virtual Reality interesting.



Left: Ata Bozaci – Detail Stamp Festival, 2014 / Right: Ata Boza

You might have heard about this, but in case you haven't, here it is: Kanye West claimed in an interview for a French media outlet that he will receive an honorary doctorate...



Banksy's Silent Majority Goes under the Hammer

March 18, 2015

Early and truly unique work by famous Banksy, Silent Majority, has finally got a Certificate of Authenticity from artist's team at Pest Control. This Banksy's masterpiece from...



Fifteen Seconds of Fame At Soon Gallery

March 18, 2015

There is no doubting the power social media has over our lives in contemporary society, its impact

Social Media Digital Portraits

Both the book and solo exhibition of Ata Bozaci, *Beautiful Facebook – Fifteen Seconds of Fame*, are collections of digital portraits created by the artist, based on full frontal photos from Facebook profiles. The artworks blur the line between the physical and virtual world by removing the images from social media and placing them out of context, either as prints or in mural form as street art. The full frontal digitised artworks concentrate on the facial features of his social media friends, drawing attention to the iconic nature of the photos used on Facebook profiles, while also utilising the excellent illustration and design skills that Ata Bozaci possesses. The combination of graphic design along with his graffiti writing skills, has resulted in a collection of original works that are quite striking in *Beautiful Facebook – Fifteen Seconds of Fame*. You may also enjoy the work of [Richard Prince](#) in *New Portraits* and the [Is Instagram a New Artistic Medium?](#) article.

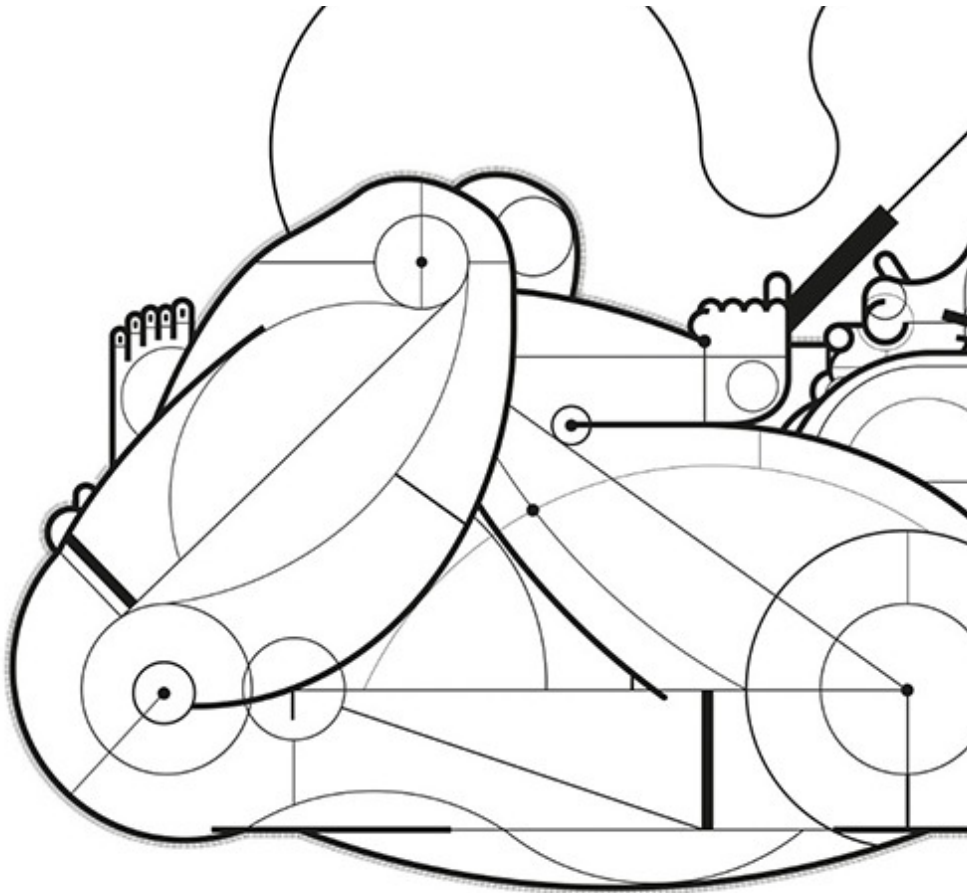

Ata Bozaci – Online, 2014

has been quite unnerving at times in recent years. Social media has become an...



Street Update #67

March 18, 2015

It's that time of the week again, when Widewalls takes a look at what our globetrotting street artist friends have been doing in terms of murals! Mexico has seen an influx of...

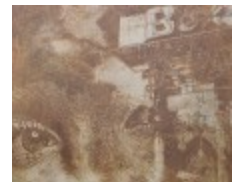

Vhils At Lazarides Rathbone

March 18, 2015

Lazarides Rathbone, the London based gallery, has announced a forthcoming multidisciplinary exhibition by Portuguese graffiti and street artist Alexandre Farto aka Vhils. This new...

Ata Bozaci

Swiss born artist Ata Bozaci, aka Toast, originally studied new media and graphic design while also experimenting with graffiti and spray cans in the early 1990's. His works were largely inspired by classic graffiti writing and he has gone on to become a versatile artist, who explores across various mediums and techniques. His artworks encompass drawing, murals, canvas paintings, modular sculptures, graphic art and three-dimensional graffiti writing. The *Beautiful Facebook – Fifteen Seconds of Fame* book is his second monograph and follows *Black Ink*, published in 2007.

Beautiful Facebook – Fifteen Seconds of Fame by Ata Bozaci, aka Toast, opens at [SOON Gallery](#), Bern, on 19th March, 2015 and runs through until 29th March, 2015.

For all the latest exhibition news sign up to [My Widewalls](#) today!





Ata Bozaci – Stamp Festival, :



LET'S STAY IN TOUCH!

Your email address

Sign up



Ata Bozaci – Detail Yagmur Rue

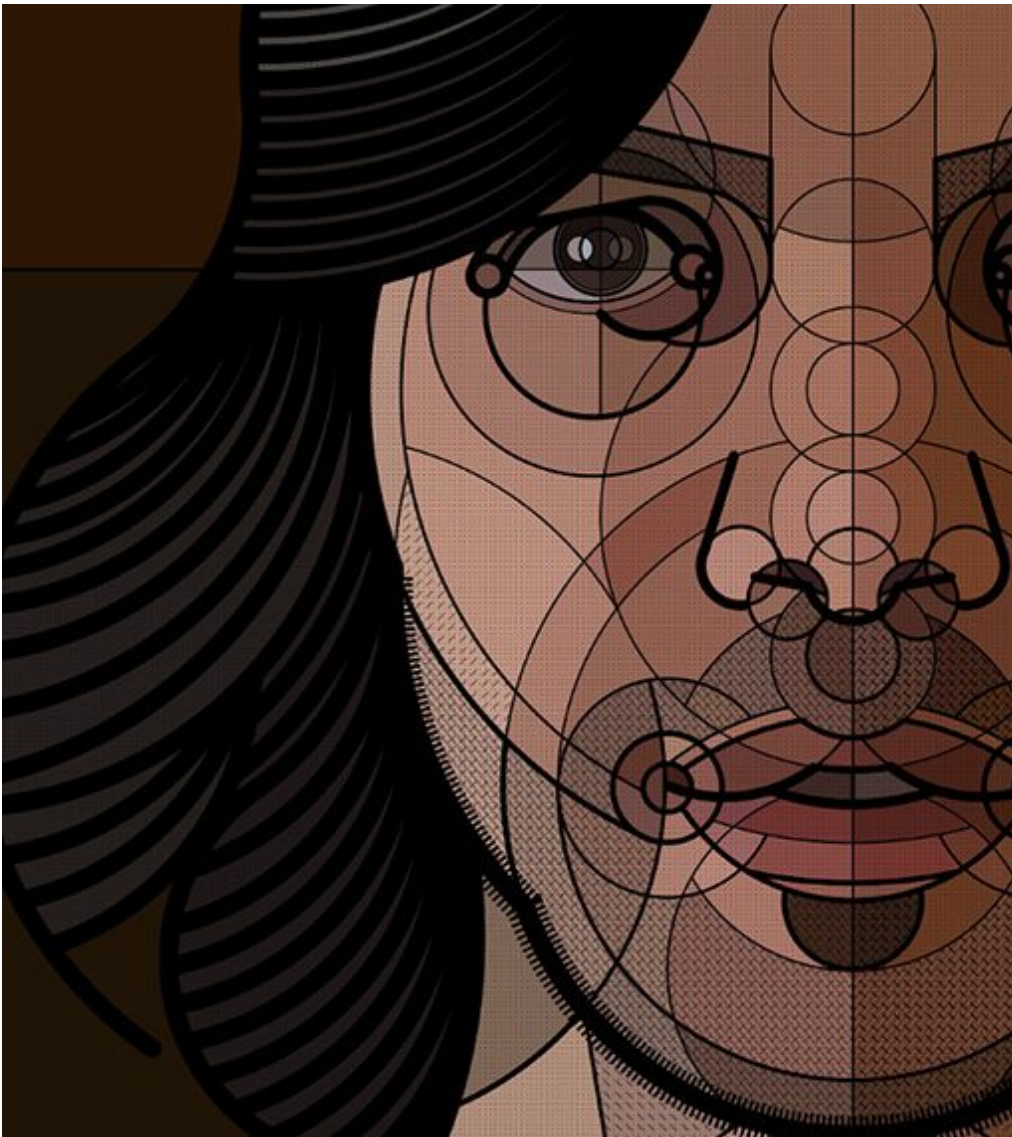

Ata Bozaci – Detail Pedro Mendoz

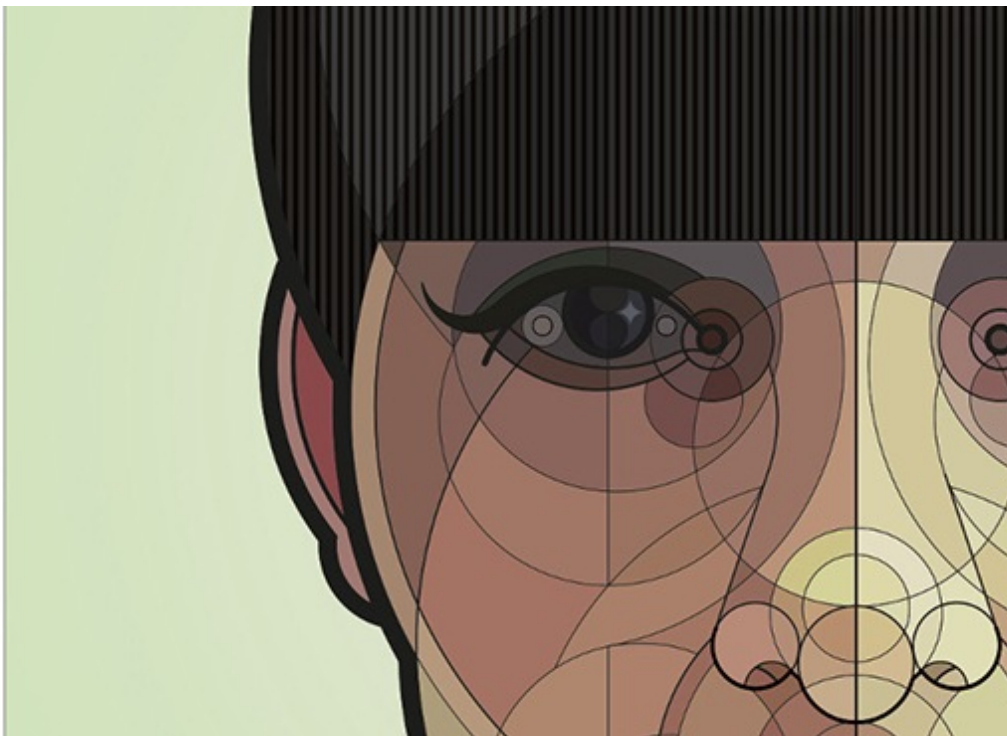

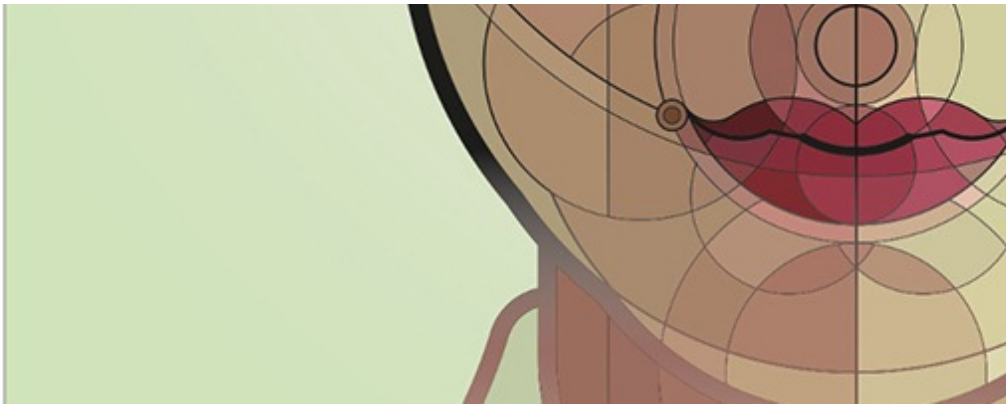

Ata Bozaci – Detail Maja Medic, Banker

All images courtesy of SOON Gallery.

LET`S STAY IN TOUCH!

Your email address

Sign up

RELATED POSTS



Vhils At Lazarides Rathbone

March 18, 2015

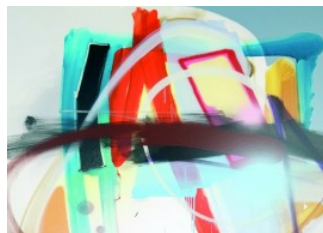

Smash137: Streunergold

March 17, 2015



Sotheby's: Bear Witness Auction Analysis

March 14, 2015

QUICKLINKS

- MAGAZINE
- BLOG
- ARTISTS
- TV
- LOCATOR
- EVENTS

WIDEWALLS

- ABOUT US
- IMPRINT
- CONTACT
- JOBS
- PROJECTS
- BACKROOM

ART COLLECTORS

- THE WIDEWALLS COLLECTION
- ART COLLECTIONS
- COLLECTORS TIP
- UPCOMING EXHIBITIONS
- UPCOMING AUCTIONS

ABOUT WIDEWALLS

WIDEWALLS AIMS TO BE THE PREMIER URBAN & CONTEMPORARY ART RESOURCE FOR COLLECTORS. WE ARE

[STREET UPDATE](#)

[ADVERTISE WITH US](#)

[AUCTION RESULTS](#)

[INTERESTED IN](#)

[INTERVIEWS](#)

[PROVIDING UNIQUE](#)

[FEATURES](#)

[ADDED VALUE.](#)

[TOP LISTS](#)

**LET'S STAY IN
TOUCH!**

© 2015 WideWalls | Urban & Contemporary Art Resource Made for you by WIDEWALLS. All rights reserved [†]